

# ESTANFI

## AUTOMOCION

ESPECIALISTAS EN LAND ROVER, 4x4 y TRANSMISIONES



# CATÁLOGO MANGUITOS

# 2015

Adaptables a Mitsubishi Montero 3.2 DID

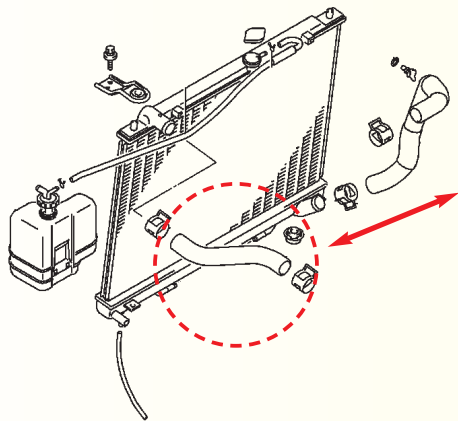

Manguito radiador superior  
**Ref. MR404865**  
Montero 3.2 DID  
(02/00-08/06)



**Ref. 1370A108**  
Montero 3.2 DID  
(09/08 ->)

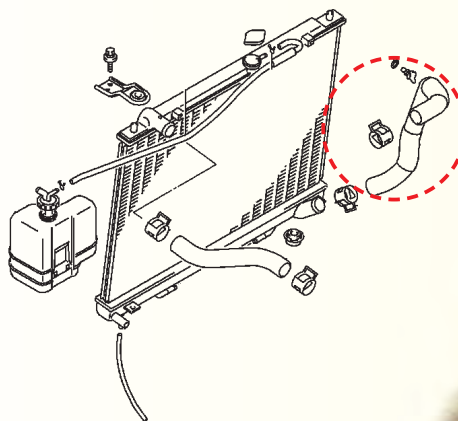

Manguito radiador inferior  
**Ref. MR404872**  
Montero 3.2 DID  
(02/00-08/06)



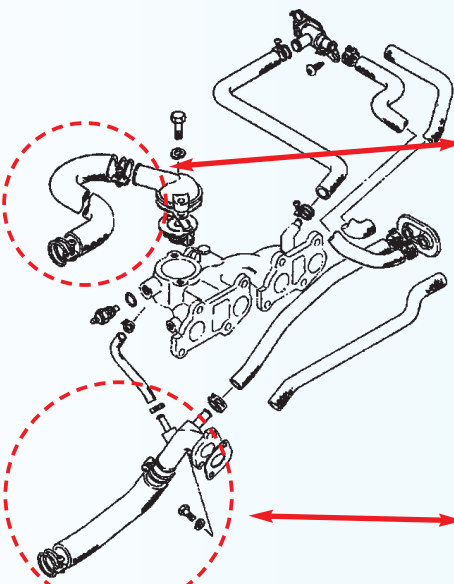



Manguito radiador superior  
**Ref. 17841-80000**  
SJ410  
Samurai 1000

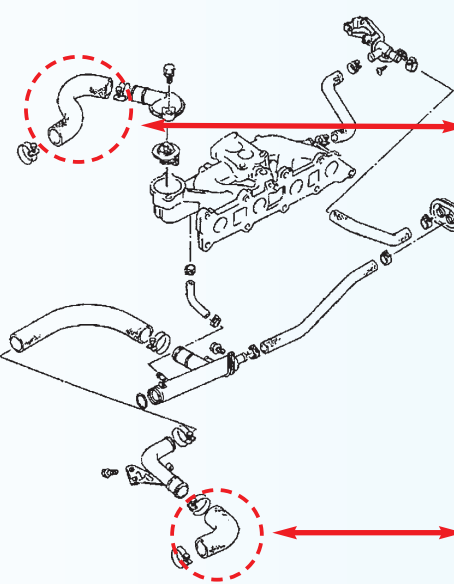

Manguito radiador inferior  
**Ref. 17851-80000**  
SJ410  
Samurai 1000





Manguito radiador superior  
**Ref. 17841-83001**  
Samurai 1300 gasolina





Manguito radiador inferior  
**Ref. 17851-83101**  
SJ413 y Samurai 1300

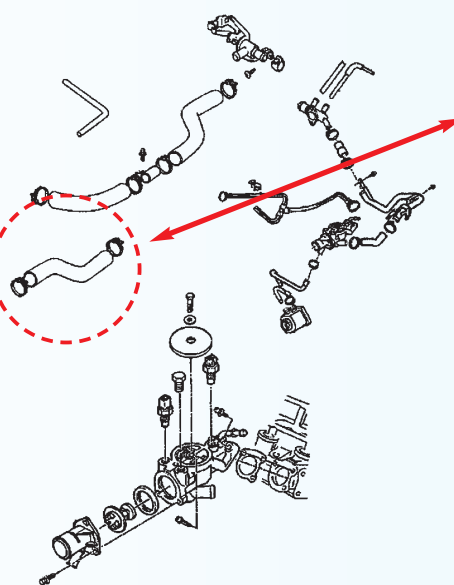

Manguito radiador inferior  
**Ref. 17851-60A00**  
SJ413 y Samurai 1300



Manguito radiador inferior  
**Ref. 17851-84CA0**  
Samurai 1900 diesel



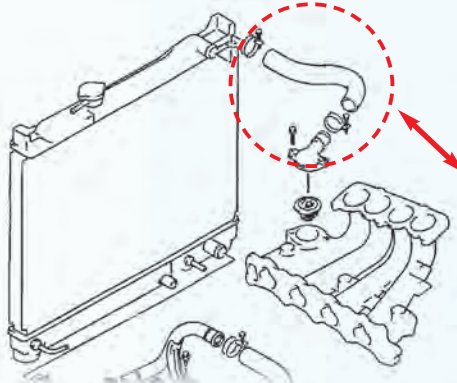

Manguito radiador superior  
**Ref. 17841-85C10**  
Vitara 1600 - 16 válvulas



**Ref. 17841-85C00**  
Vitara 1600 - 8 válvulas



Manguito radiador superior  
**Ref. 17842-86CA0**  
Vitara 1.9 D y TD



Manguito radiador superior  
**Ref. 17851-86CB1**  
Vitara 1.9 D



Manguito radiador inferior  
**Ref. 17851-60A00**  
Vitara 1600 - 3 puertas



Manguito de llenado  
**Ref. 89241-84CA0**  
Samurai (todos)



Manguito radiador superior  
**Ref. 17851-86CG0**  
Vitara 2000 HDI



**Manguito radiador superior**  
**Ref. 21501-EB300**  
 Navara 2.5 D (05/05 ->)

**Manguito radiador inferior**  
**Ref. 21503-EB300**  
 Navara 2.5 D (05/05 ->)

**Manguito radiador superior**  
**Ref. 21501-OF111**  
 Terrano II (02/93 - 05/96)

**Ref. 21501-7F000**  
 Terrano II (05/96 - 10/99)

**Manguito radiador inferior**  
**Ref. 21503-OF111**  
 Terrano II (02/93 - 05/96)

**Ref. 21503-OF112**  
 Terrano II (02/93 - 05/96)

**Ref. 21503-7F000**  
 Terrano II (05/96 - 10/99)

**Manguito radiador inferior**  
**Ref. 2150386J20**  
 X-Trail (T30) 3.5 4x4

**Manguito radiador superior**  
**Ref. 21501G9804**  
 Patrol K160 y K260 2.8 TD

**Manguito radiador superior**  
**Ref. 2150316N00**  
 Terrano II 2.7 TDi 4WD

**Manguito radiador superior**  
**Ref. 2150186J21**  
 X-Trail (T30) 3.5 4x4

Las marcas, logotipos y coches usados exclusivamente como referencia.

